

Article number: 3901030015200

Description: Worm gear with solid input shaft
VF 30A-15-HS

Measures

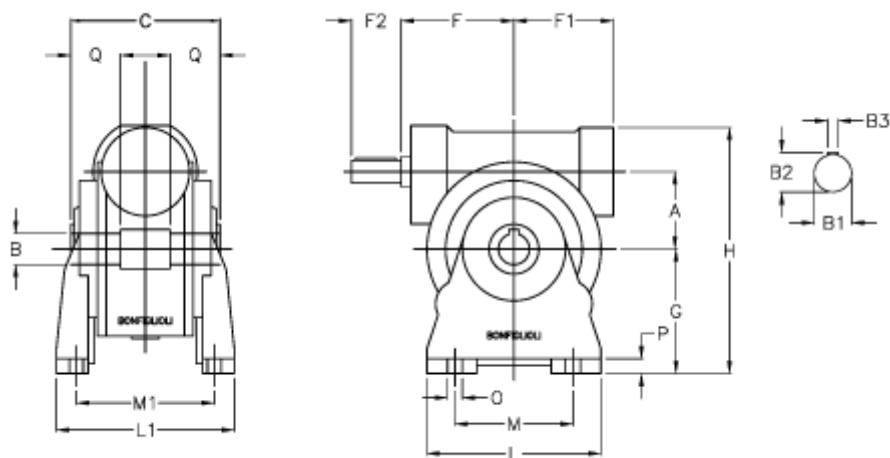

a	= 30.0	F1 = 46	P = 8
B	= 14	g = 55	Q = 20.5
B1 E7	= 9	H = 105	
B2	= 10.2	L = 80	
B3 H9	= 3	L1 = 80	
C	= 55	m = 50	
Description = VF 30A-xx-HS	M1 = 66.0		
F	= 50.0	O = 6.5	